



OPTISWITCH 6600 C Technical Datasheet

Capacitance Level Switch for standard hygienic applications

- Optimised sensor geometry, easy to clean
- Measures products with dielectric constant > 1.5
- Small and compact



1 Product features	3
1.1 Switch for level detection and dry-run protection	3
1.2 Options and variants	5
1.3 Measuring principle	6
2 Technical data	7
2.1 Technical data	7
2.2 Dimensions and weights	10
2.3 Temperature limits	12
3 Installation	14
3.1 Intended use	14
3.2 General notes on installation	14
3.3 Installation requirements	14
3.4 Process connection	14
4 Electrical connections	15
4.1 Safety instructions	15
4.2 Electrical connection diagrams	15
5 Order information	17
5.1 Device order code	17
5.2 Order code for process connections options	19
6 Notes	21

1.1 Switch for level detection and dry-run protection

The **OPTISWITCH 6600 C** is a level switch for level detection and dry-run protection for liquids and solids. Through its small and optimal sensor shape, the device is easy to clean and the risk of clogging of sticky products is minimised.

The device measures liquids such as water and beer and even viscous and sticky products such as honey or toothpaste. Solids (sugar or flour) can be also measured. The measurement is precise and not affected by the mounting position. Coating of the sensor or condensate are not detected.

The OPTISWITCH 6600 C is resistant to CIP and SIP agents. Hygienic installation is possible with the comprehensive range of accessories. For further information refer to chapter "Order information".



- ① Standard version
- ② Hygienic version
- ③ LED for switching point indication

Highlights

- Process temperature -40 ... +115°C / -40...+239°F
- Insensitive to build up or foam
- Measures alternating media
- LED switching point indication
- Hygienic switch entirely made of stainless steel
- Excellent for media separation
- No blockage of the pipeline

Industries

- Food & Beverage
- Pharmaceuticals
- Cosmetics

Typical applications

- Level detection of mustard
- Dry-run protection of cream
- Level detection of ketchup

1.2 Options and variants

LED indication



The information that the switching point is triggered, is been indicated by a blue light.

Pipe assembly



The construction with the reverse-threaded G 1/2 connection can be mounted in a pipe.

Electrical connection is made via a 5 m / 16.4 ft long cable.

Configuration tool



The configuration tool connects the OPTISWITCH 6600 C with a computer. With a corresponding software, it is possible to fine tune the switching point, change the hysteresis or adjust damping.

1.3 Measuring principle

A high frequency signal sweep is radiated from the sensor tip into the tank / pipe. The medium will act as a virtual capacitor, which together with a coil in the sensor head, will form a circuit creating the switching point signal. This virtual capacity will depend of the dielectric value of the medium and it is well defined for most media.

The measurement is precise and unaffected by the mounting position.

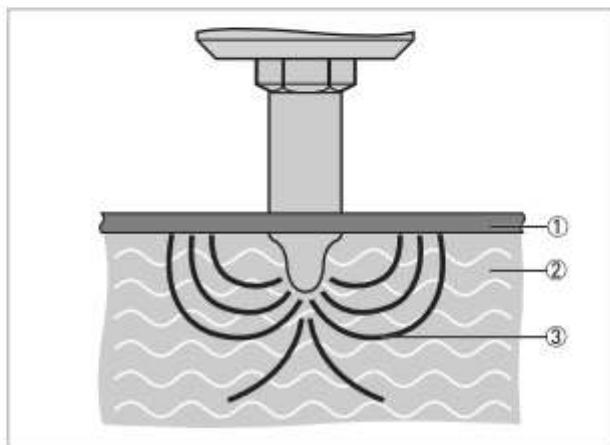

- ① Tank wall / pipe wall
- ② Medium
- ③ Line of electric flux

2.1 Technical data

- *The following data is provided for general applications. If you require data that is more relevant to your specific application, please contact us or your local sales office.*
- *Additional information (certificates, special tools, software,...) and complete product documentation can be downloaded free of charge from the website (Downloadcenter).*

Measuring system

Measuring principle	Electromagnetic wave, 100..180 MHz
Application range	Level detection, dry-run protection and media separation of liquids and solids.

Design

Construction	The measurement system consists of a measuring sensor and the electronic unit which is available in a compact version. The switching point is signalled by a blue LED indication at the neck of the M12 connector.
Options	Teach-In function for applications where the medium is hard to detect.
Accessories	Comprehensive range of adapters and process connections for hygienic installation. Please refer to the specific data sheet "Accessories".

Measuring accuracy

Repeatability	±1 mm / ±0.04"
Hysteresis	±1 mm / ±0.04"
Reference conditions acc. to EN 60770	
Temperature	+20°C ±5°C / +68°F ±41°F
Pressure	1013 mbar abs. ±20 mbara / 14.69 psi abs. ±0.29 psia
Humidity (IEC 68-2-38)	< 98% RH, condensing

Operating conditions

Temperature	
Ambient temperature (T _{amb})	-40...+85°C / -40...+185°F
Storage temperature	-40°C...+85°C / -40...+185°F
Process temperature	-40...+115°C / -40...+239°F (refer to separate diagram) +135°C / +275°F < 1 hour, T _{amb} < +50°C / +122°F
Pressure	
Ambient pressure	Atmospheric
Process pressure	G 1/2 hygienic connection max. 10 bar / 145 psi Sliding connection max. 5 bar / 70 psi
Other conditions	
Ingress protection (acc. to EN 60529)	IP67 equivalent to NEMA 4X IP69K (with the appropriate cable)

Installation conditions

Installation	In any position. For more data, refer to <i>Installation</i> on page 14.
Dimensions and weights	For more data, refer to <i>Dimensions and weights</i> on page 10.

Materials

Sensor housing	Stainless steel 1.4404 / 316L
Process connection	
Sensor insulation	Virgin PEEK, FDA / Regulation (EC) No 1935:2004 / Regulation (EC) No 2023:2006
Electrical connection	Plug M12: nickel-plated brass
Surface Roughness of wetted part	Ra < 0.8µm (Ra < 0.4µm in option)

Process connections

Standard	G 1 A, G ½A and ½ NPT
Other	For more data about process connection options, refer to <i>Device order code</i> on page 17.

Electrical connections

Power supply	12...30 V DC, 35 mA max.
Power consumption	25 mA typical, 50 mA max.
Power-up time	< 2 s
Reaction time	0.1 s typical (0.15 +/- 0.05 s)
Damping	0...10 s
Cable entry	M12 (4 pin Polycarbonate) or M12 (4 pin stainless steel)

Output

Output (active)	Max. 20 mA, short-circuit and high-temperature protected
Output type	PNP or NPN
Output polarity	Reverse polarity protected
Voltage drop Active "Low"	NPN; (-V DC + 1.5 V) ± 0.5 V; R _{load} = 10 kilohms
Voltage drop Active "High"	PNP; (V DC - 1.5 V) ± 0.5 V; R _{load} = 10 kilohms
Factory settings	Switching range < 75% (sr > 2)
	Damping: 0.1 s
Off leak current	±100 µA max.

Approvals and certifications

CE	This device fulfils the statutory requirements of the EU directives. The manufacturer certifies successful testing of the product by applying the CE marking.
Other standards and approvals	
Electromagnetic compatibility (EMC)	EN 61326-1 (2006)
Vibration resistance	IEC 60068-2-6, GL test 2
Hygiene	3-A / EHEDG, materials agree with FDA / Regulation (EC) No 1935:2004 / Regulation (EC) No 2023:2006

Explosion protection	<p>ATEX II 1 G Ex ia IIC T4/T5</p> <p>Maximum values (for barrier selection): U_i: 30 V DC ; I_i: 100 mA; P_i: 0.75 W Internal capacitance, C_i: 43 nF Internal inductance L_i: 10 μH</p> <p>Temperature class: $T1...T4$: $-40^\circ\text{C} < T_{\text{amb}} < +85^\circ\text{C}$ $T1...T5$: $-40^\circ\text{C} < T_{\text{amb}} < +74^\circ\text{C}$ ①</p>
	<p>ATEX II 1 D Ex ta IIIC T100 °C Da</p> <p>Voltage supply range 30 V DC max. Temperature class T100 °C: $-40^\circ\text{C} < T_{\text{amb}} < +85^\circ\text{C}$ Protection class of cable accessory IP67</p>
	<p>ATEX II 3 G Ex nA II T4/T5</p> <p>Voltage supply range 30 V DC max. Temperature class $T1...T4$: $-40^\circ\text{C} < T_{\text{amb}} < +85^\circ\text{C}$ $T1...T5$: $-40^\circ\text{C} < T_{\text{amb}} < +74^\circ\text{C}$</p>

① Recommended barrier: PROFSI3-b25100-ALG-LS

2.2 Dimensions and weights

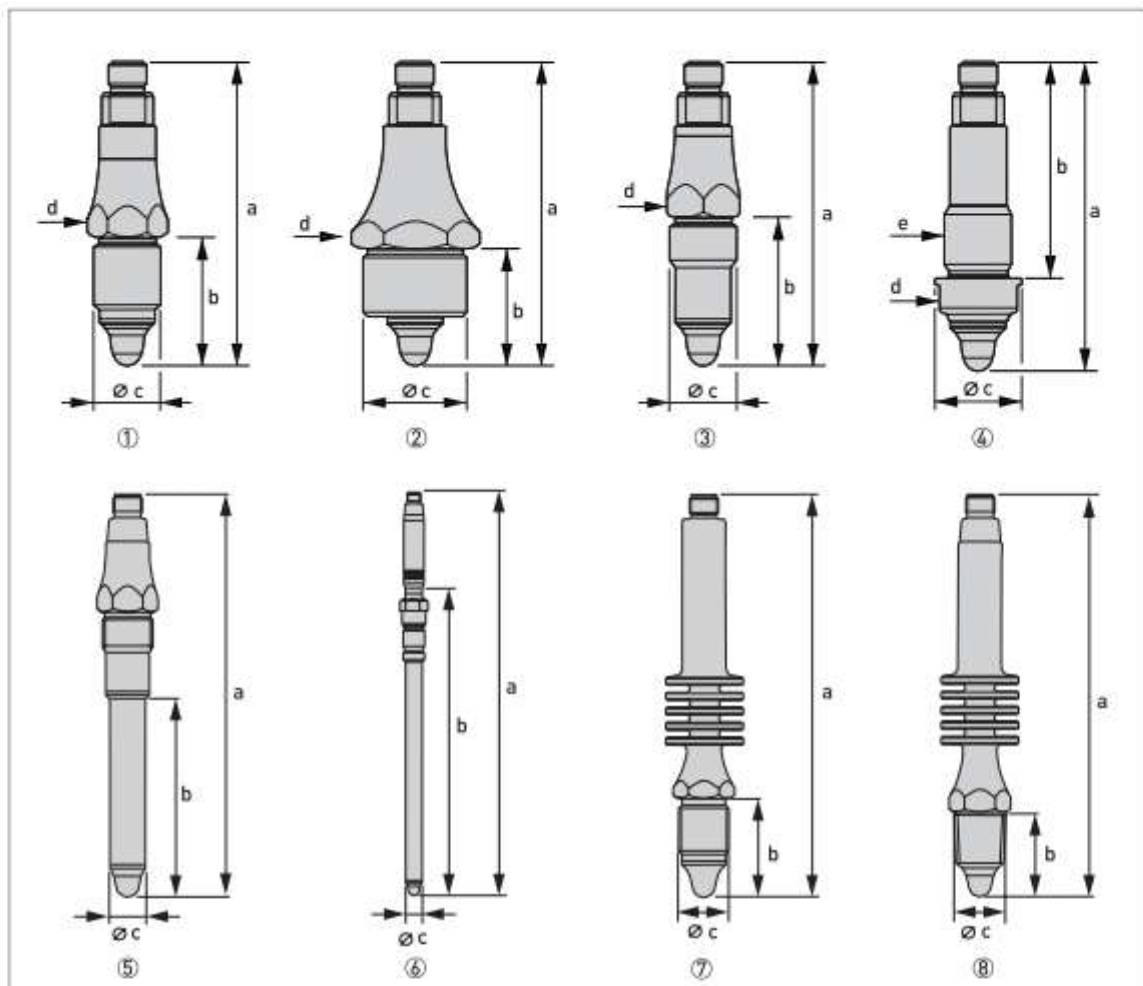

- ① Standard G ½ version
- ② G 1 version
- ③ Hygienic G ½ version
- ④ Reverse-threaded G ½ version
- ⑤ Hygienic long sensor length G ½
- ⑥ Long sensor length G ½ (sliding connection)
- ⑦ Standard sensor length (with cooling neck)
- ⑧ ½ NPT Standard sensor length (with cooling neck)

	Dimensions		Approx. weight without adapter	
	[mm]	[inch]	[kg]	[lb]
Standard G ½ or ½"NPT version				
a	97	3.82	0.1	0.22
b	41	1.61		
c	G ½ or ½"NPT – ISO 228/1			
d	WS 22	WS 0.87		
G 1 version				
a	97	3.82	0.15	0.33
b	38	1.50		
c	G 1 – ISO 228/1			
d	WS 36	WS 1.41		
Hygienic G ½ version				
a	97	3.82	0.1	0.22
b	48	1.89		
c	G ½ – ISO 228/1			
d	WS 22	WS 0.87		
Reverse-threaded G ½ version				
a	97	3.82	0.1	0.22
b	68	2.68		
c	Ø27	Ø1.06		
d	WS 24	WS 0.94		
e	G ½ A – ISO 228/1			
Hygienic long sensor length G ½ version				
a	166	6.54	0.12	0.27
b	117	4.61		
c	14.6	0.55		
Long sensor length G ½ version (sliding connection)				
a	357	14.06	0.25	0.55
b	272	10.71		
c	14.6	0.55		
Standard sensor length (with cooling neck)				
a	166	6.54	0.21	0.46
b	41	1.61		
c	G ½			
½ NPT standard sensor length (with cooling neck)				
a	166	6.54	0.21	0.46
b	35	1.38		
c	½ -14 NPT			

2.3 Temperature limits

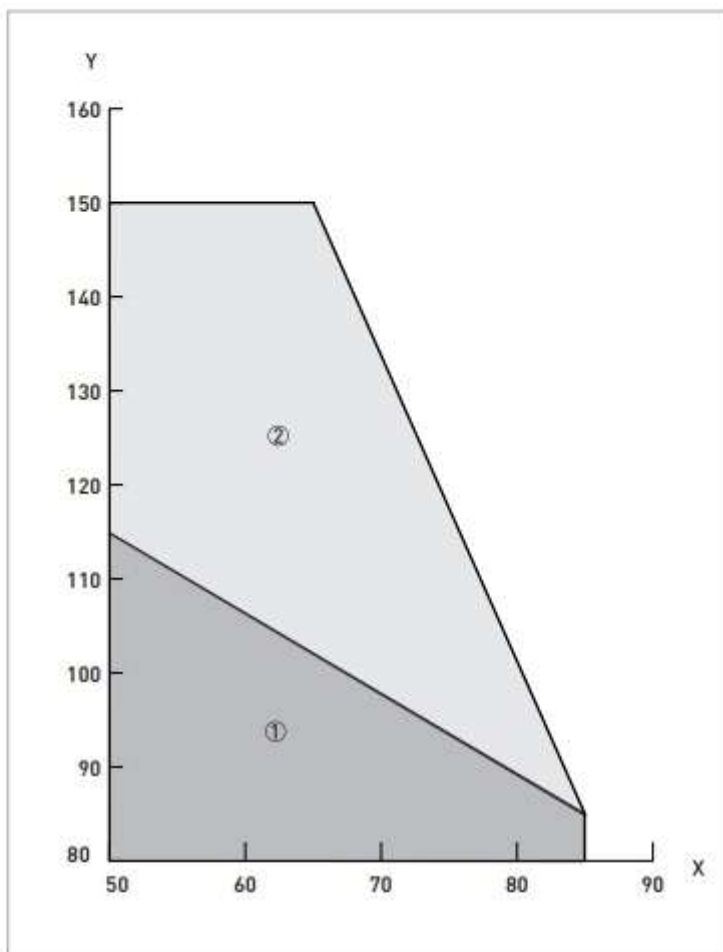

Figure 2-1: For all process connections except sliding connection

X: Ambient temperature in [°C]

Y: Process temperature max in [°C]

① Without cooling neck

② With cooling neck

		Projecting length min. (mm)					
		25	35	50	65	90	145
Process temperature [C°]	200						
	190						
	180						
	170						
	160						
	150						
	140						
	130						
	120						
	110						
	100						
	90						
	80						
	70						
60							
		35	40	45	50	55	60
		Ambient temperature [°C]					

Figure 2-2: For process connection with sliding connection

3.1 Intended use

The OPTISWITCH 6600 C is a level switch for level detection and dry-run protection for liquids and solids. The device measures liquids such as water and beer and well as viscous and sticky products such as honey or toothpaste. Even dry medias can be measured such as sugar or flour.

The measurement is precise and not affected by the mounting position.

Coating of the sensor or condensate is not detected.

3.2 General notes on installation

Inspect the packaging carefully for damages or signs of rough handling. Report damage to the carrier and to the local office of the manufacturer.

Do a check of the packing list to make sure that you have all the elements given in the order.

Look at the device nameplate to ensure that the device is delivered according to your order. Check for the correct supply voltage printed on the nameplate.

3.3 Installation requirements

- For the hygienic version, only use the original KROHNE sleeves or adapters. If other systems are used, no guarantee can be given for proper functionality or leak-tightness.
- The connection thread must have direct electrical contact with the threaded sleeve and the metal tank or pipe.
- At the hygienic connection G ½ do not use Teflon or paper gaskets between switch and hygienic adapter. The PEEK sensor together with the stainless steel adapter will perform a hygienic tightening. Assumed that the requirements have been followed.
- The tightening torque for hygienic connection G ½ should be 10...15 N·m.

3.4 Process connection

The hygienic ½" process sleeve is easy to weld into tanks or pipes. This kind of assembly allows installation in conformity with standards of hygiene (to 3-A, EHEDG, FDA, Regulation (EC) No 1935:2004, Regulation (EC) No 2023:2006). The G ½ and G 1 connections can be mounted in any counter thread according to ISO 228.

Various hygienic adapter sleeves are available for fitting to other process connections. For more data, refer to "Order information".

The sensor can be installed in any desired position.

4.1 Safety instructions

All work on the electrical connections may only be carried out with the power disconnected. Take note of the voltage data on the nameplate!

Observe the national regulations for electrical installations!

For devices used in hazardous areas, additional safety notes apply; please refer to the Ex documentation.

Observe without fail the local occupational health and safety regulations. Any work done on the electrical components of the measuring device may only be carried out by properly trained specialists.

Look at the device nameplate to ensure that the device is delivered according to your order. Check for the correct supply voltage printed on the nameplate.

4.2 Electrical connection diagrams

Description of normally open (NO) and normally closed (NC)

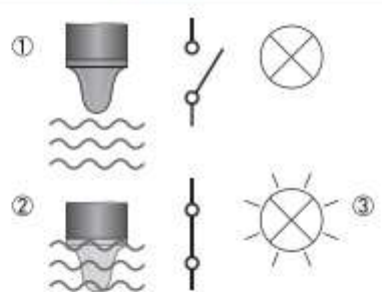
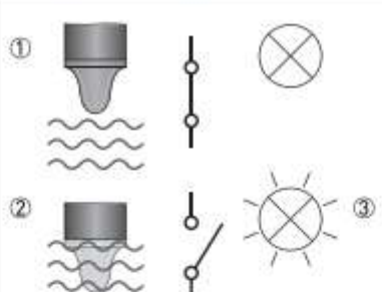
Normally open	Normally closed
 <p>① 0 mA ② 20 mA ③ LED</p>	 <p>① 20 mA ② 0 mA ③ LED</p>

PNP

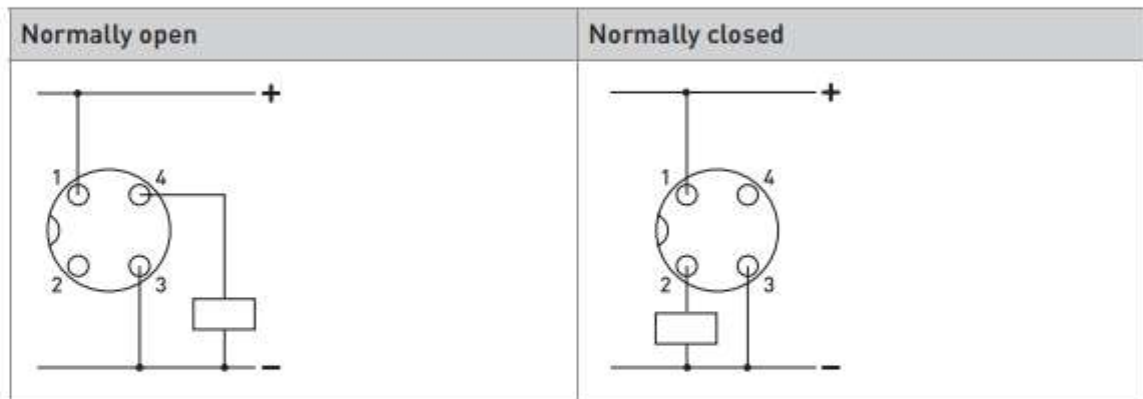

NPN

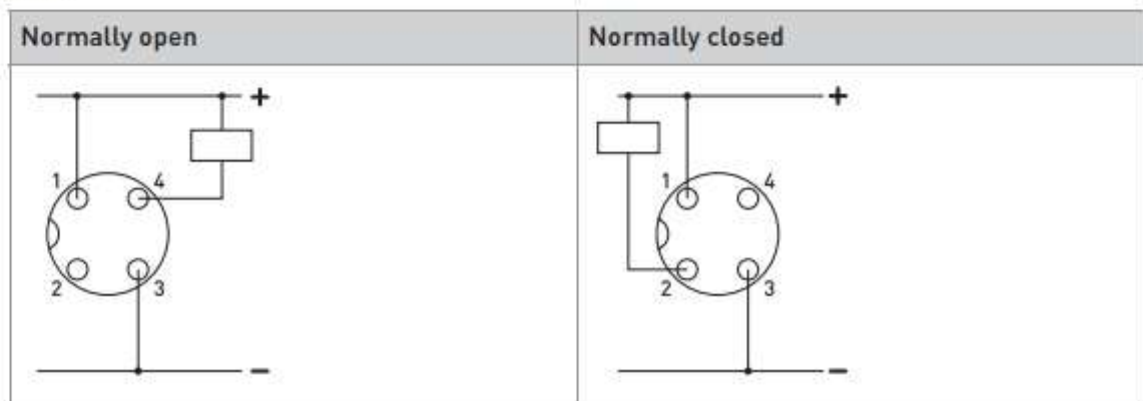

M12 plug

1: brown; 2: white; 3: blue; 4: black

5.1 Device order code

VGPA	4	1	OPTISWITCH 6600 C, with IP67 [equivalent to NEMA 4X], stainless steel housing – materials agree with FDA / Regulation (EC) No 1935:2004 / Regulation (EC) No 2023:2006 The use of VGP7 process connections is required for 3-A / EHEDG approved switches.
			Process connection
		1	G ½ A – standard sensor length 15 mm / 0.6" (for use with hygienic process connections)
		2	G 1 A – standard sensor length 15 mm / 0.6" (non-hygienic)
		3	G ½ A – standard sensor length 15 mm / 0.6" (non-hygienic)
		4	G ½ A – for reverse mounting (non-hygienic)
		6	G ½ A – Long sensor length 82 mm / 3.2" (hygienic with hygienic process connection)
		7	G ½ A – Long sensor length 250 mm / 9.8" (sliding connection / for hygienic use)
		B	G ½ A – Standard sensor length 15 mm / 0.6" (with cooling neck / non-hygienic)
		G	½"NPT – Standard sensor length 15 mm / 0.6" (non-hygienic)
		H	½"NPT – Standard sensor length 15 mm / 0.6" (with cooling neck / non-hygienic)
			Electrical connection
		1	M12 – 4-pin connector plug
		2	IP67; 5 m / 16.4 ft non-shielded cable with flying leads (max. temperature: +70°C / +158°F)
		4	M12 – 4-pin connector plug (stainless steel), no LED
			Approvals
		0	Without
		3	ATEX II 1G Ex ia IIC T5 ①
		4	ATEX II 1D Ex ta IIIC T100°C Da ①
		5	ATEX II 1G Ex ia IIC T4/T5 and ATEX II 1D Ex ta III T100°C Da ①
			Output
		0	PNP output
		1	NPN output
			Output configuration
		0	Standard
		1	Customer settings – based on data from an installed device. "% of triggering, damping, hysteresis, output mode" to be specified separately.
			Other Approvals
		0	None
		A	Food contact (FDA rules, EC 1935/2004, EC 2023/2006 and EU 10/2011)
		B	Food contact (FDA rules, EC 1935/2004, EC 2023/2006 and EU 10/2011) + 3-A® + EHEDG - only with process connection code 1 (G1/2 A) and in combination with hygienic adapters
VGPA	4	1	Order code [complete this code on the pages that follow]

											Surface Finish
											0 Standard 0.8 µm surface roughness
											1 0.8 µm surface roughness - electro-polished
											2 0.4 µm surface roughness
VGPA	4	1									Order code

① For more data about how to order this option, speak to your supplier

Order code for configuration tool (incl. interface unit + USB cable + CD with driver + alligator clips + M12 connection cable)

XGP9	0	0	0	0	0	1	0	Order code
-------------	---	---	---	---	---	---	---	------------

5.2 Order code for process connections options

Hygienic connections

Code	Old code	Description	Max. pressure		Approval options
			[barg]	[psig]	
KPW3-321	HWN 200	Weld-in sleeve (outside Ø30 mm)	100	1450	3-A® / EHEDG
KPW3-322	HWN 210	Collared weld-in sleeve	40	580	3-A® / EHEDG
KPW2-327	HWN 220	Weld-in sleeve with shoulder – for DN65...150 pipes	40	580	—
KPW2-326	HWN 220	Weld-in sleeve with shoulder – for DN25...50 pipes	40	580	—
KPW2-324	HWN 250	Spherical weld-in sleeve – for angled sensor mounting	40	580	—
KPH-32CB	HGA 200	Hygienic adapter for G 1 process connection	40	580	—
KPH1-3236	HSM 251	DN51 adapter SMS 1145 ①	25	363	—
KPH3-3213	HTC 240	1½" Tri-Clamp® DN25/40 DIN 32676, 25/38 mm ISO 2852 ①	40	580	3-A® / EHEDG
KPH3-3216	HTC 250	2" Tri-Clamp® DN50 DIN 32676, 51 mm ISO 2852 ①	40	580	3-A® / EHEDG
KPH3-3221	HMT 225	DN25 conical nozzle DIN 11851 ①	40	580	3-A® / EHEDG
KPH3-3224	HMT 240	DN40 conical nozzle DIN 11851 ①	40	580	3-A® / EHEDG
KPH3-3225	HMT 250	DN50 conical nozzle DIN 11851 ①	10	145	3-A® / EHEDG
KPH3-3254	—	DN40 conical nozzle DIN 11851 Type A ①	10	145	3-A® / EHEDG
KPH3-3255	—	DN50 conical nozzle DIN 11851 Type A ①	40	580	3-A® / EHEDG
KPH3-324E	HVF 250	DN40/50 Varivent® Type N	10	145	3-A® / EHEDG
KPW2-621	—	3-A® DN38 weld in tank part ①	40	580	3-A® / EHEDG
KPW2-626	—	3-A® DN38 weld in pipe extrusion	40	580	3-A® / EHEDG
KPX5-32	HST 200	Allen screw blanking plug	100	1450	—
KPH1-32A1	—	E&H FTL – process connection code EE2, Rd 52	40	580	—
KPH1-32BA	—	E&H FTL – process connection code GQ2 (G ¾), Ø23.7 mm	40	580	—
KPH1-32BC	—	Vegaswing – process connection codes GB/GBV (G ¾), Ø21.3 mm	40	580	—
KPH1-32CD	—	Vegaswing – process connection codes GA/GAV (G 1), Ø21.3 mm	40	580	—
KPI1-A2D	—	G 1½ Cable holder for use with OPTISWITCH 6600 solids	10	145	—

① To order union nuts and gaskets, refer to "Accessories" in the section that follows.

Non-hygienic connections

Code	Old code	Description	Max. pressure		Approval options
			[barg]	[psig]	
KPW1-721	NWN 200	Weld-in sleeve (outside Ø30 mm) for thick wall tank	100	1450	—

All hygienic process connections agree with FDA regulations, Regulation (EC) No 1935:2004 and Regulation (EC) No 2023:2006.

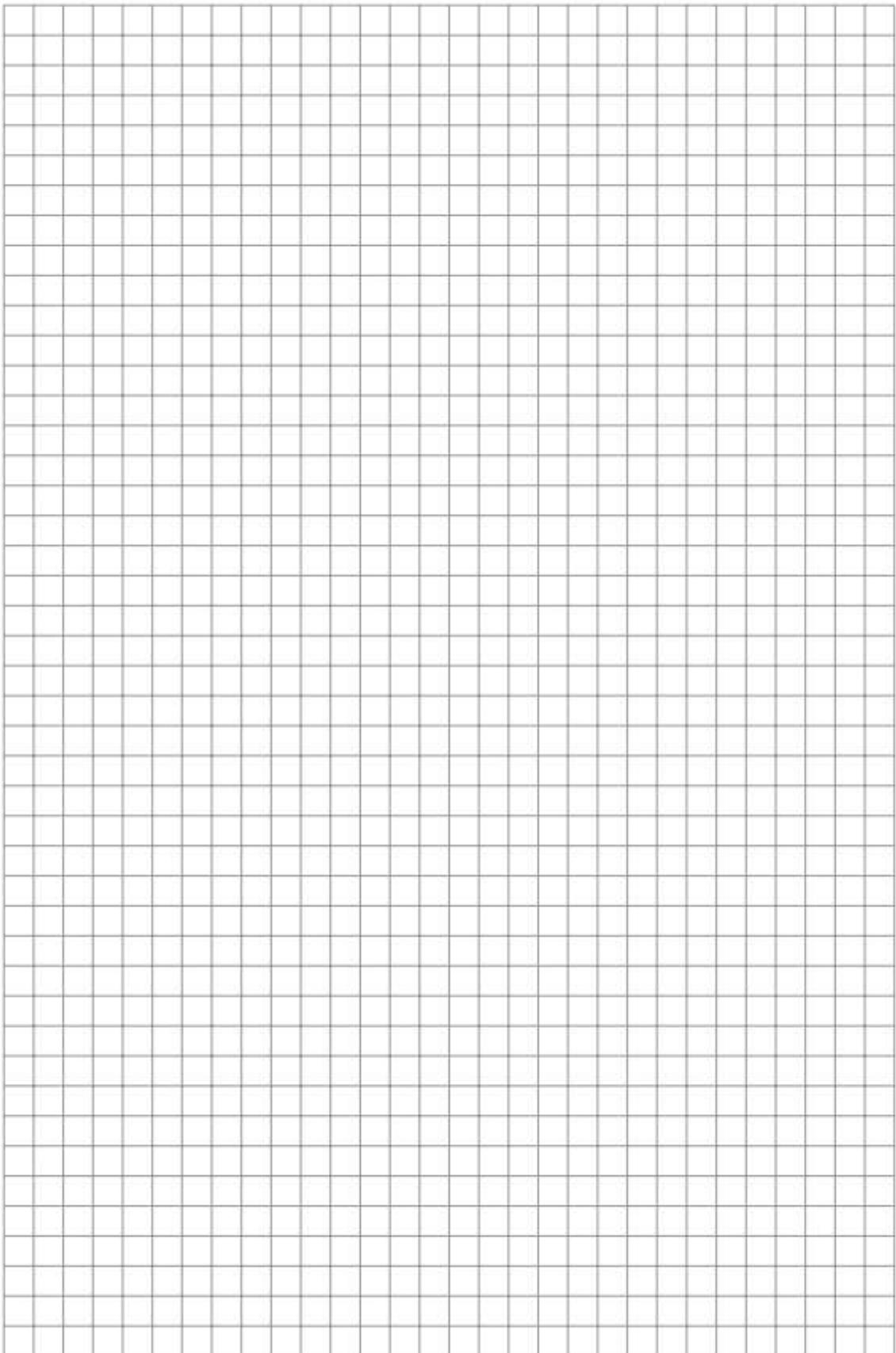

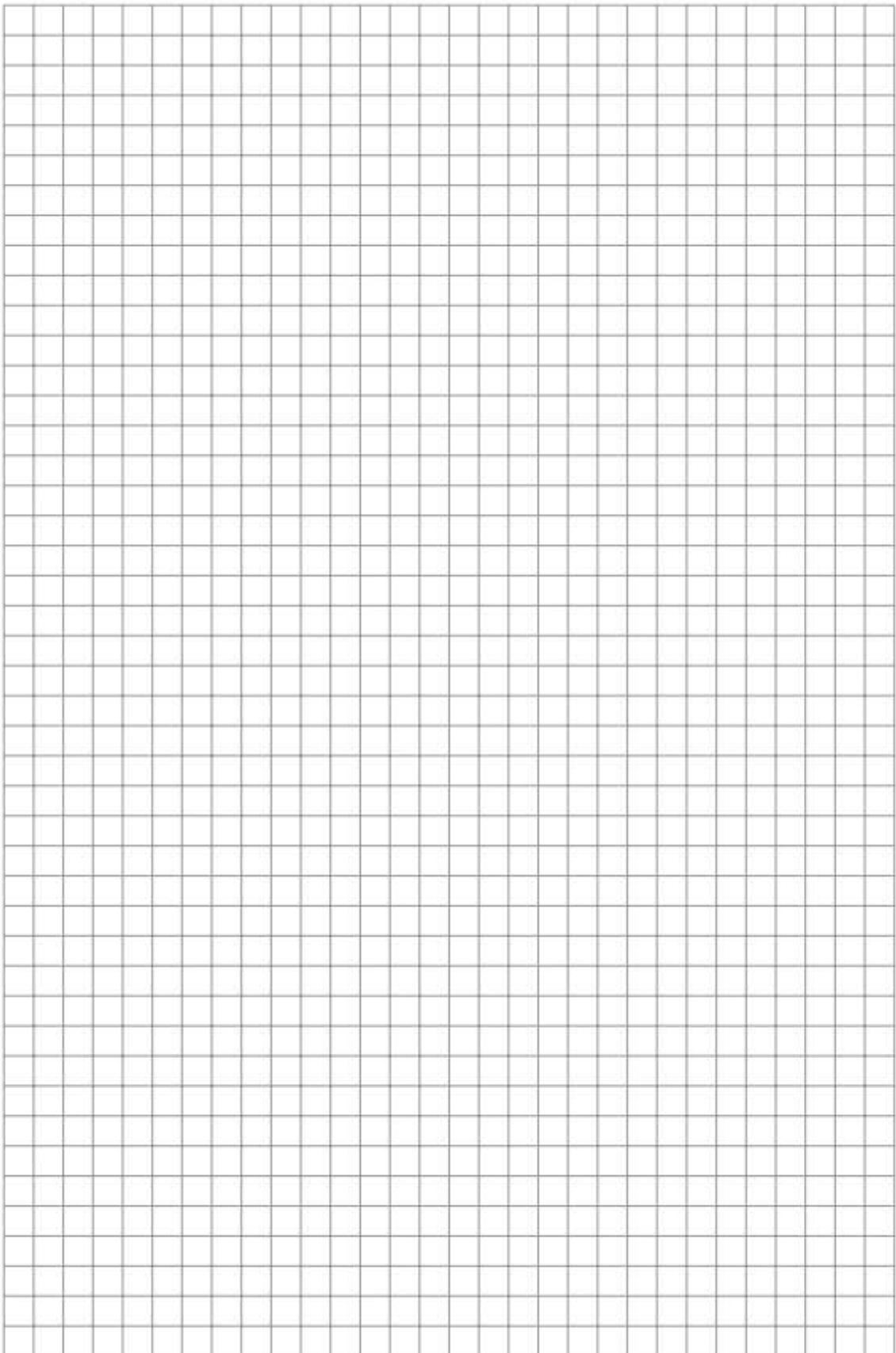

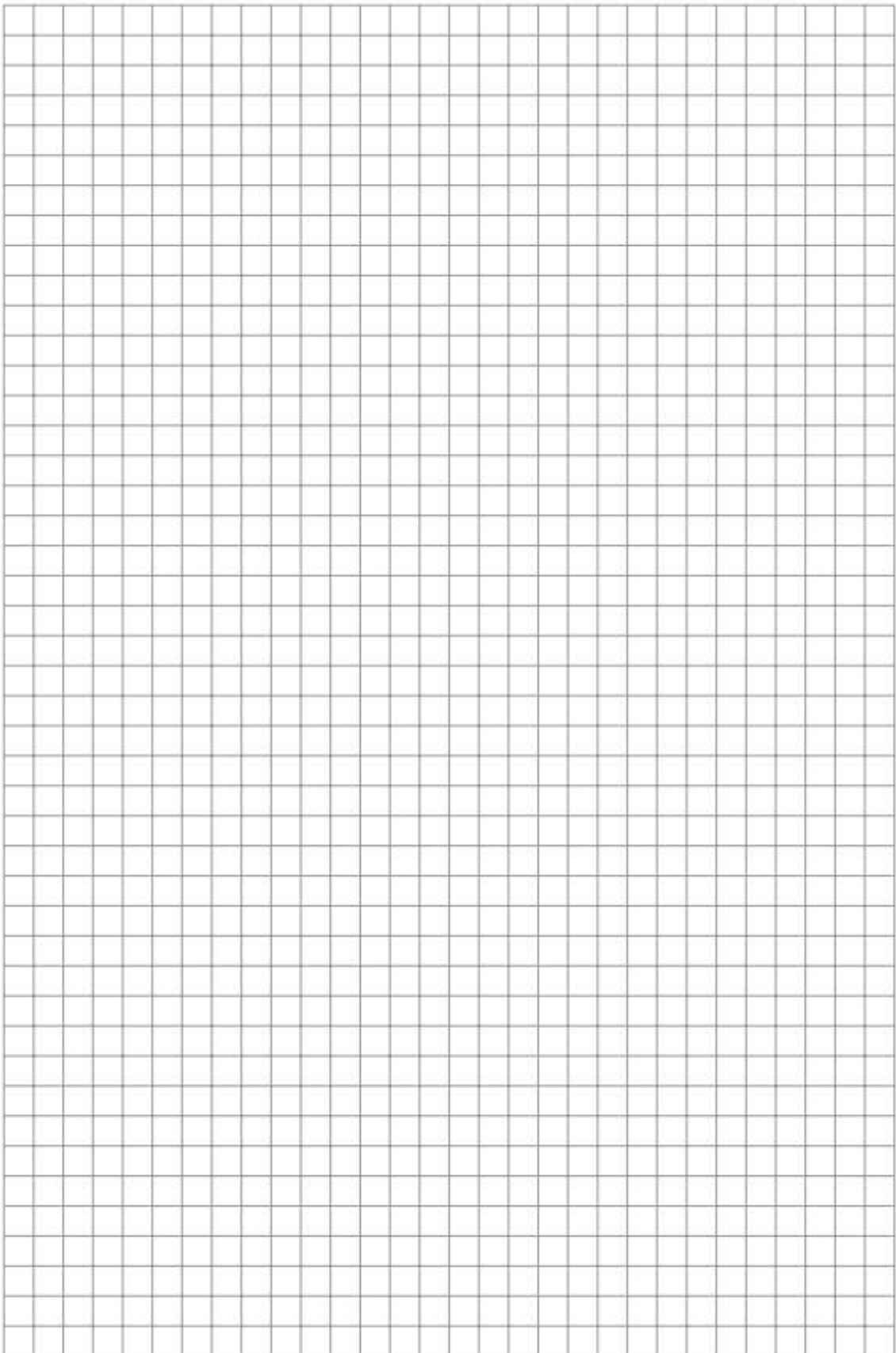



KROHNE – Process instrumentation and measurement solutions

- Flow
- Level
- Temperature
- Pressure
- Process Analysis
- Services

Head Office KROHNE Messtechnik GmbH
Ludwig-Krohne-Str. 5
47058 Duisburg (Germany)
Tel.: +49 203 301 0
Fax: +49 203 301 10389
info@krohne.com

The current list of all KROHNE contacts and addresses can be found at:
www.krohne.com

KROHNE