

Euro gauge

Industrial service pressure gauge (Internal brass)

Model : P253 series

Spec. sheet no. PD02-08

Service intended

Sturdy industrial pressure gauge designed in compliance with the operational safety requirements of EN 837-1.
Reliable pressure gauge for the machine and plant.
For gaseous and liquid media that are not highly viscous or crystallising and will not attack copper alloy parts.



Nominal diameter

63, 100 and 160 mm

Accuracy

P2532 (63 mm) : ± 1.6 % of full scale

P2534 (100 mm) and P2536 (160 mm) : ± 1.0 % of full scale

Scale range (MPa, kPa, bar)

63 mm : -0.1 ~ 0 to 0 ~ 35 MPa

100 and 160 mm : -0.1 ~ 0 to 0 ~ 100 MPa

Working pressure

Steady : 75 % of full scale (63 mm)

100 % of full scale (100 and 160 mm)

Over range protection : 130 % of full scale

Working temperature

Ambient : -20 ~ 60 °C

Fluid : Max. 60 °C

Degree of protection

EN60529/IEC529/IP65

Temperature effect

Accuracy at temperature above and below the reference temperature (20 °C) will be effected by approximately ± 0.4 % per 10 °C of full scale



Standard features

Pressure connection

Brass

Element

Brass

Model : P2534 (100 mm) and P2536 (160 mm)

<10 MPa : C type bourdon tube

≥ 10 MPa : Helical type bourdon tube with 316SS

Model : P2532 (63 mm)

<6 MPa : C type bourdon tube

≥ 6 MPa : Helical type bourdon tube

Blowout protection

Back, Rubber disc for 100 and 160 mm

Top, Rubber disc for 63 mm

Case

Stainless steel (304SS)

Cover

Stainless steel (304SS)

Bayonet type

Window

Laminated safety glass

Movement

63 mm : Brass

100 and 160 mm : Stainless steel

Dial

White aluminium with black graduations

Pointer

Black painted aluminium alloy

Process connection

63 mm : $\frac{1}{4}$ " PT, NPT and PF

100 and 160 mm : $\frac{1}{4}$ ", $\frac{3}{8}$ ", $\frac{1}{2}$ " PT, NPT and PF

Certificates

ATEX Ex II GD c IIc TX

Option

Zero adjustable pointer

(Only available with diameter 100 and 160 mm)

WISE[®]

I P253_01

1. Base model

P253 Industrial service pressure gauge (Internal brass)

2. Nominal diameter (mm)

2 63
4 100
6 160

3. Type of mounting

A Bottom connection, direct
B Bottom connection, surface, case mounting plate
F Center back connection, direct, only available with diameter 63 mm
G Lower back connection, direct, only available with diameter 100 mm
H Center back connection, flush, case center mounting plate, only available with diameter 63 mm
I Center back connection, flush, case center mounting plate with bracket, only available with diameter 63 mm
J Center back connection, flush, cover mounting plate, only available with diameter 63 mm
L Lower back connection, flush, case center mounting plate, only available with diameter 100 mm
M Lower back connection, flush, case center mounting bracket, only available with diameter 100 mm
N Lower back connection, flush, cover mounting plate, only available with diameter 100 mm
V Center back connection, flush, cover mounting bracket, only available with diameter 63 mm
W Lower back connection, flush, cover mounting bracket, only available with diameter 100 mm

4. Accuracy

3 ±1.0 % of full scale, not available with diameter 63 mm
4 ±1.6 % of full scale, only available with diameter 63 mm

5. Process connection

C ¼"
D ⅜", Not available with diameter 63 mm
E ½", Not available with diameter 63 mm

6. Connection type

B PF
C PT
D NPT
F BSPT
G BSP (G)
Z Other

7. Unit

H bar
I MPa
J kPa
Z Other

8. Range

XXX Refer to pressure unit and range table

9. Dial color

1 2 colors
5 3 colors

10. Option

0 None
1 Accessories

1	2	3	4	5	6	7	8	9	10
P253	4	A	3	E	D	H	XXX	1	0

Sample
ordering code

P253 : Type of mounting (1/2)

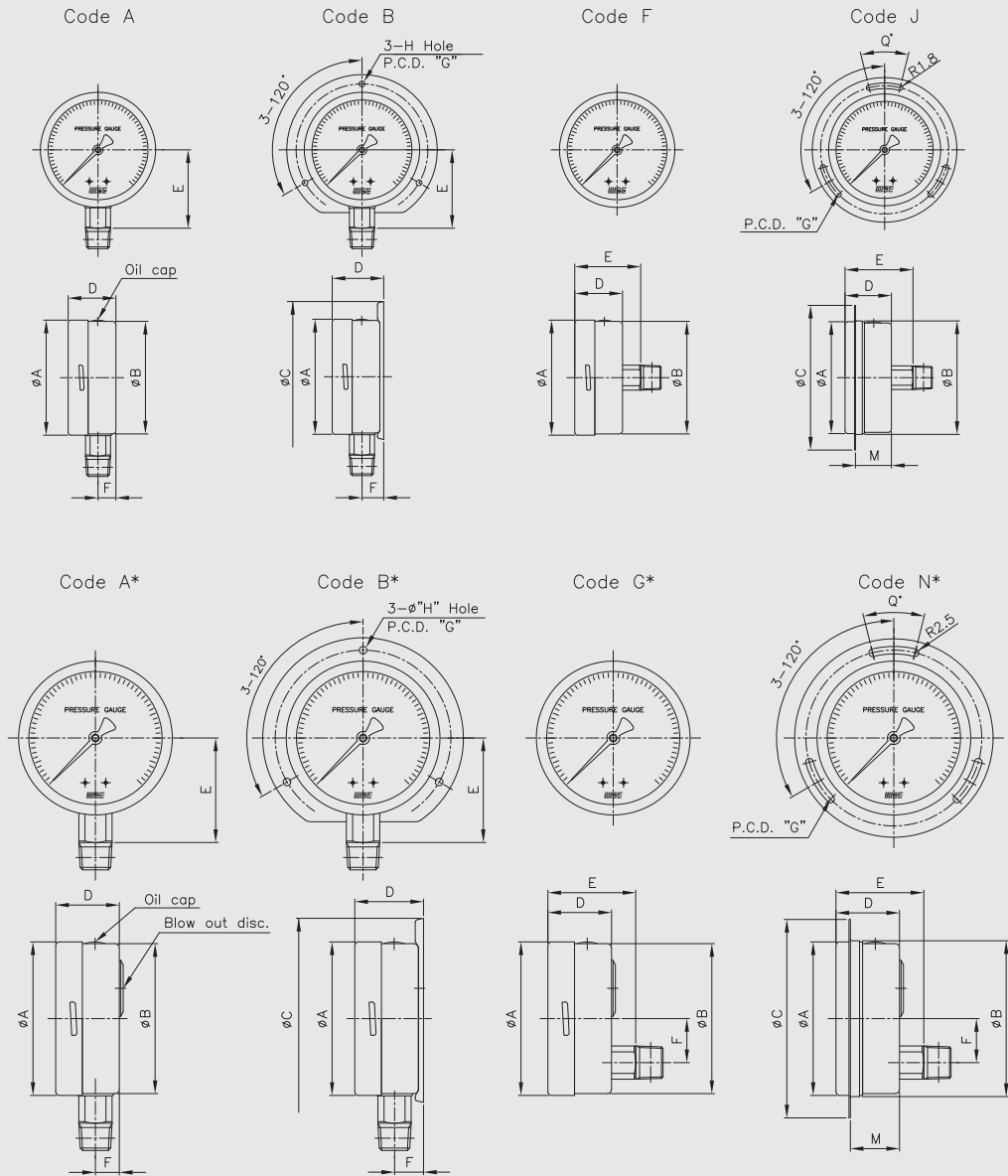

Dimensions (mm)

Dial size	Available code	A	B	C	D±2	E±2	F±1	M	G	H	Q
63	A	64	62		34	41.7	11				
	B	64		85	37	41.7	15		74~75		
	F	64	62		34	45					
	J	64	66	86	34	45		28	75		15
100	A*	101.3	99		50	65	16				
	B*	101.3		133	54.4	65	19.4		115~116	R2.5	
	C*	101.3	99		50	65	29				
	N*	101.3	103.1	130.5	50	65	29	45	116		28
160	A*	160.6	159		52.5	94	15.8				
	B*	160.6		196	56	94	19.3		178	5.8	

P253 : Type of mounting (2/2)

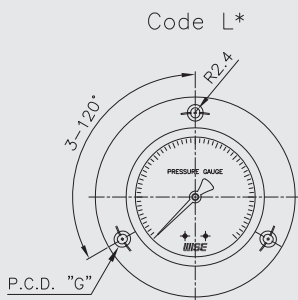
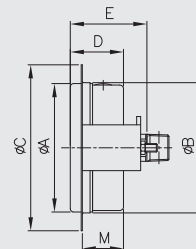
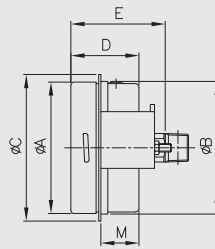
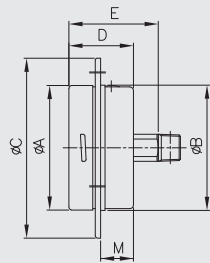
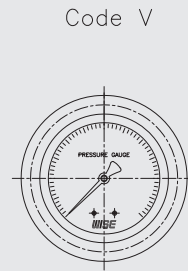
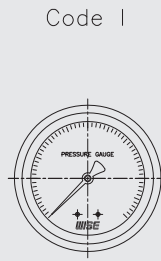
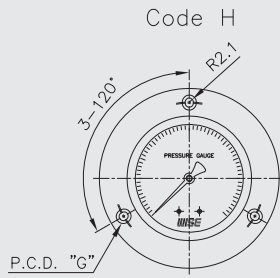

Code M*

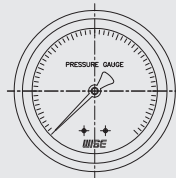

Code W*

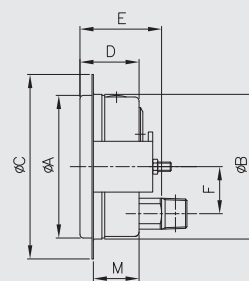
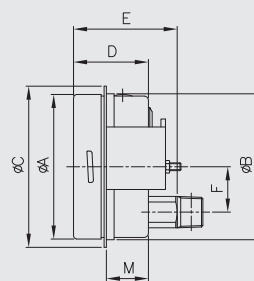
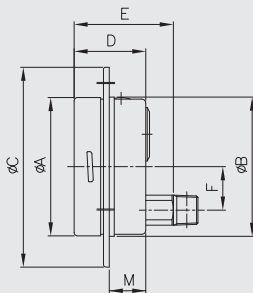
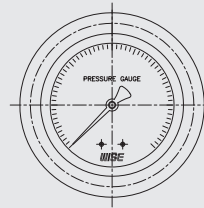

Dimensions (mm)

Dial size	Available code	A	B	C	D ± 2	E ± 2	F ± 1	M	G
63	H	64	64.5	92	34	45			77~78
	I	64	63.7	71	34	45		18.5	
	V	64	66	86	34	45		28	
100	L*	101.3	100.4	132	50	65	29	27.7	115~116
	M*	101.3	101	107.5	50	65	29	29.5	
	W*	101.3	103.1	130.5	50	65	29	45	

Pressure unit and range table

Range and code	Unit and code			Nominal diameter		
	H : bar	I : MPa	J : kPa	63 mm	100 mm	160 mm
026	-1 ~ 0	-0.1 ~ 0	-100 ~ 0	O	O	O
041	0 ~ 1	0 ~ 0.1	0 ~ 100	O	O	O
133	0 ~ 1.6	0 ~ 0.16	0 ~ 160	O	O	O
042	0 ~ 2	0 ~ 0.2	0 ~ 200	O	O	O
134	0 ~ 2.5	0 ~ 0.25	0 ~ 250	O	O	O
043	0 ~ 3	0 ~ 0.3	0 ~ 300	O	O	O
044	0 ~ 4	0 ~ 0.4	0 ~ 400	O	O	O
045	0 ~ 6	0 ~ 0.6	0 ~ 600	O	O	O
047	0 ~ 10	0 ~ 1	0 ~ 1,000	O	O	O
050	0 ~ 15	0 ~ 1.5	X	O	O	O
143	0 ~ 16	0 ~ 1.6	X	O	O	O
051	0 ~ 20	0 ~ 2	X	O	O	O
052	0 ~ 25	0 ~ 2.5	X	O	O	O
054	0 ~ 35	0 ~ 3.5	X	O	O	O
151	0 ~ 40	0 ~ 4	X	O	O	O
055	0 ~ 50	0 ~ 5	X	O	O	O
056	0 ~ 60	0 ~ 6	X	O	O	O
057	0 ~ 70	0 ~ 7	X	O	O	O
058	0 ~ 100	0 ~ 10	X	O	O	O
059	0 ~ 150	0 ~ 15	X	O	O	O
060	0 ~ 160	0 ~ 16	X	O	O	O
062	0 ~ 250	0 ~ 25	X	O	O	O
064	0 ~ 350	0 ~ 35	X	O	O	O
065	0 ~ 400	0 ~ 40	X	X	O	O
066	0 ~ 500	0 ~ 50	X	X	O	O
067	0 ~ 600	0 ~ 60	X	X	O	O
068	0 ~ 700	0 ~ 70	X	X	O	O
070	0 ~ 1,000	0 ~ 100	X	X	O	O
027	-1 ~ 1	-0.1 ~ 0.1	-100 ~ 100	O	O	O
007	-1 ~ 1.5	-0.1 ~ 0.15	-100 ~ 150	O	O	O
028	-1 ~ 2	-0.1 ~ 0.2	-100 ~ 200	O	O	O
029	-1 ~ 3	-0.1 ~ 0.3	-100 ~ 300	O	O	O
030	-1 ~ 4	-0.1 ~ 0.4	-100 ~ 400	O	O	O
010	-1 ~ 5	-0.1 ~ 0.5	-100 ~ 500	O	O	O
031	-1 ~ 6	-0.1 ~ 0.6	-100 ~ 600	O	O	O
014	-1 ~ 9	-0.1 ~ 0.9	-100 ~ 900	O	O	O
032	-1 ~ 10	-0.1 ~ 1	-100 ~ 1,000	O	O	O
033	-1 ~ 15	-0.1 ~ 1.5	-100 ~ 1.5 MPa	O	O	O
034	-1 ~ 20	-0.1 ~ 2	-100 ~ 2 MPa	O	O	O
017	-1 ~ 24	-0.1 ~ 2.4	-100 ~ 2.4 MPa	O	O	O
035	-1 ~ 25	-0.1 ~ 2.5	-100 ~ 2.5 MPa	O	O	O

O : Available X : Not available